

# Railing Installation Instructions

STEP 1. MEASURE THE OPENING IN WHICH THE RAILING IS TO BE INSTALLED AND CUT THE RAILS 1/4" SHORTER THAN THE OPENING BY CUTTING 1/8" SHORTER ON BOTH ENDS. (BE SURE TO CUT EQUAL AMOUNTS ON EACH SIDE TO INSURE PROPER PICKET SPACING.)

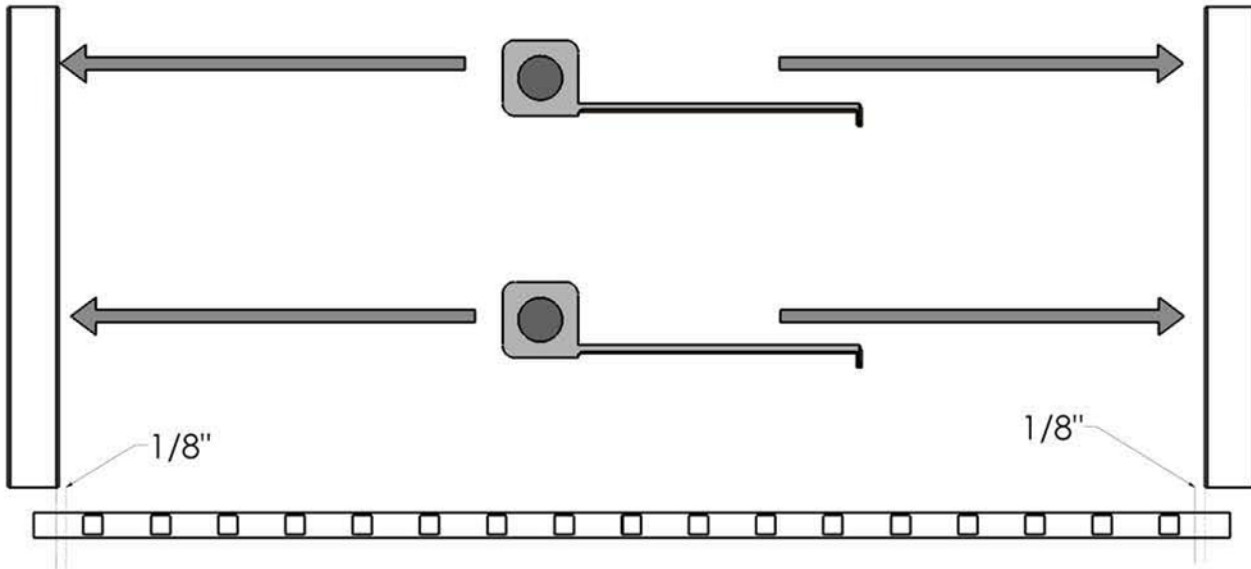

STEP 2. MARK CENTER OF POST AND ATTACH BOTTOM BRACKETS 2-1/2" FROM BOTTOM OF POST USING 3 EA. #12 x 1" SCREWS.

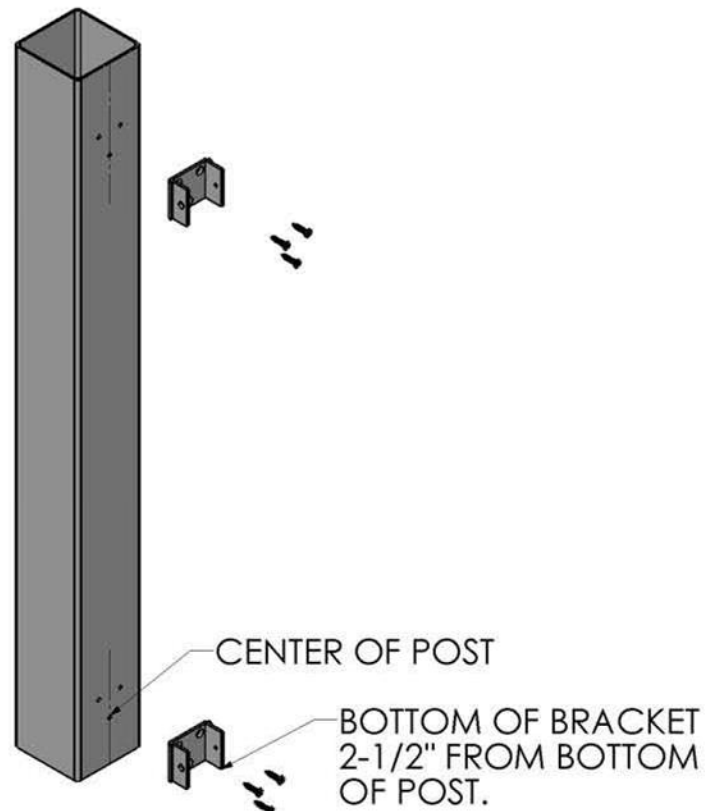

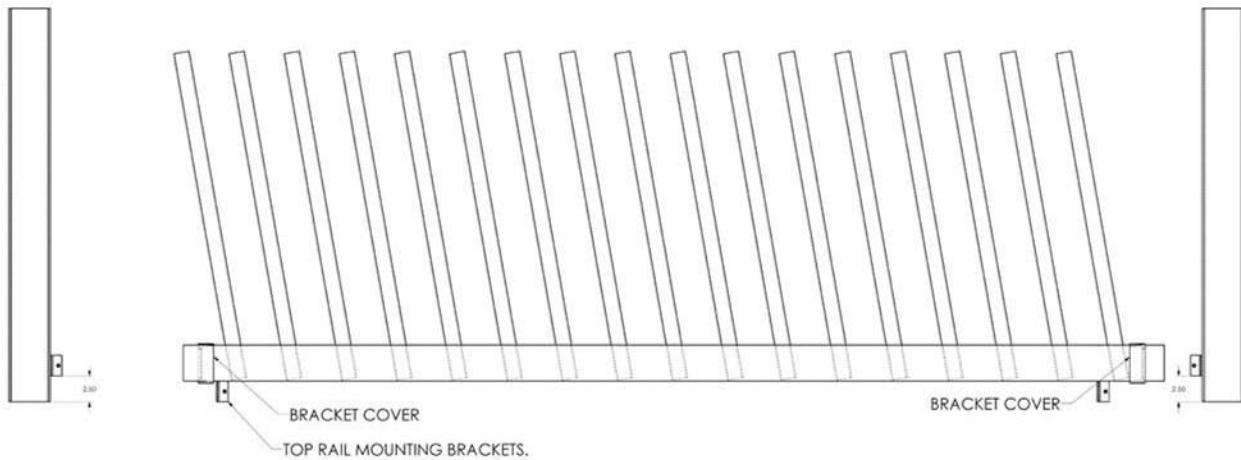

STEP 3. SLIDE BRACKET COVERS ON BOTTOM RAIL.. IF INSTALLING A 10 FOOT SECTION INSERT SUPPORT PEG (CUT TO SIZE IF NECESSARY), AND ATTACH RAIL TO THE ALUMINUM BRACKET WITH 2 EA. #8x3/4" SCREWS PROVIDED. MAKE SURE RAIL IS LEVEL BEFORE FINAL ATTACHMENT. ( TOP RAIL MOUNTING BRACKET CAN BE USED FOR 2" INCH SPACER-CHECK LOCAL CODE)

STEP 4.INSERT PICKETS IN BOTTOM RAIL. INSTALL TOP RAIL. CHECK CODE FOR PROPER HEIGHT. PLACE BRACKET 1/4 INCH ABOVE BOTTOM OF TOP RAIL. SECURE EACH BRACKET WITH 3 EA. #12 X 1" SCREWS PROVIDED.

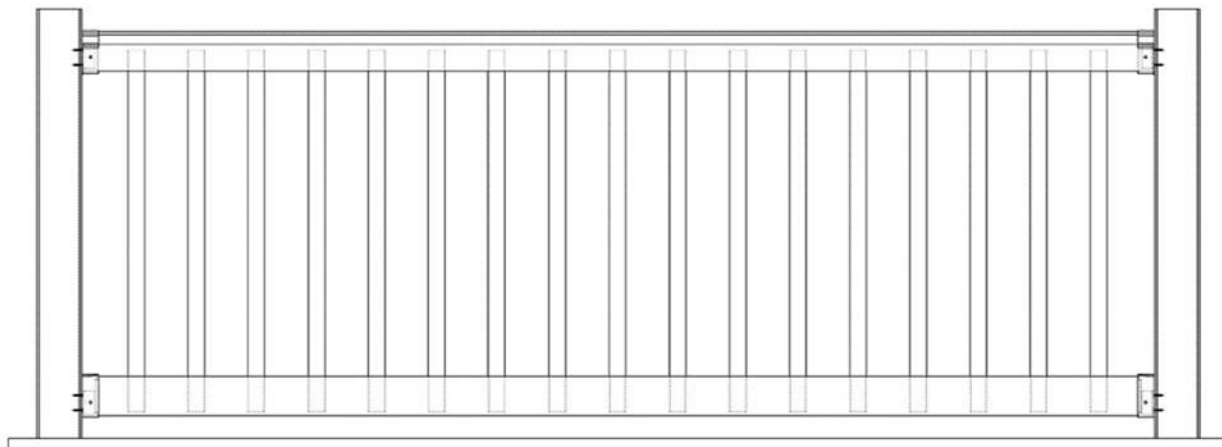
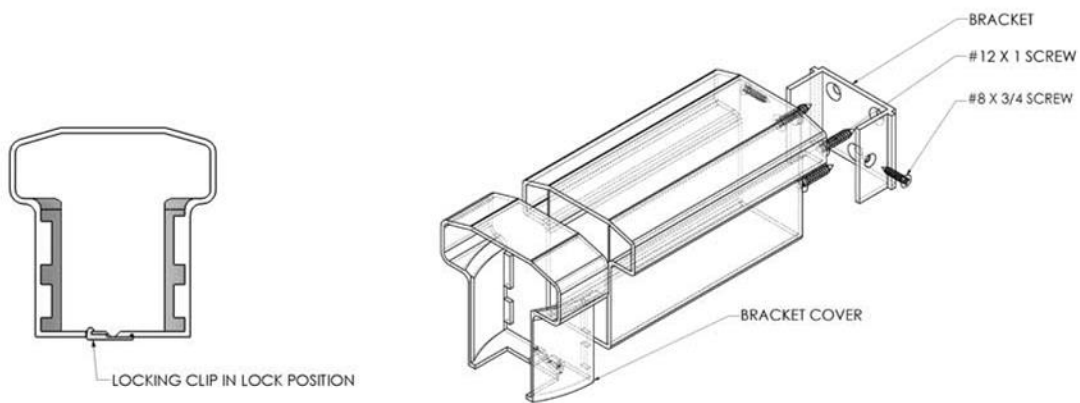

STEP 5. SLIDE ALL BRACKET COVERS IN PLACE AND SECURE LOCKING CLIPS. BRACKET COVERS SHOULD SECURE OVER ALUMINUM BRACKET.

# Stair Railing Installation Instructions

Be safe and always wear eye protection.  
Always be safety minded when using power tools.

**CAUTION!** Code and safety requirements, and any required building permits, are the responsibility of the installer. These instructions are a general guide only and may not address all installation circumstances.

## Tools Needed

- Miter saw, Cordless Drill, #2 and #3 Phillips head screw bit
- Tape measure, Level, Utility Knife, Utility Scissors, Pliers

**Remember, Measure Twice Cut Once.**



## Step 1: Railing Layout

Unpack your box, put rail section together with two pickets as shown and place section on stairs as shown for correct degree of angle and desired picket spacing from post. Mark rails on both ends, top & bottom, and set your miter saw to the angle of your stair, which is your rail cut mark.

DO NOT CUT UNTIL STEP (2c).



## Step 2: Cutting Bracket Covers & Rails

(2a) *The bottom of your bracket covers have cutout slots.* Cut bracket covers with cutout slots facing towards you. Place bottom rail with picket holes in (*towards the saw fence*). Place top rail with picket holes out (*towards you*).



(2b) Slide both bracket covers onto one end of the rail (*bottom rail 1st*) this will ensure a safe, even cut. (*Do not cut your rails to short*).

Cut your first cover at the same angle you marked your rail by holding covers and rail firmly against saw fence. Then slide covers to the other end of rail and repeat.



Repeat this on top bracket covers & rail.

(2c) Now it's time to cut your rails. Slide bracket covers off of your rails and cut on the inside of your marked lines. This will allow for the 1/8 width of the aluminum brackets. Cut your bottom rail. Repeat on your top rail with the aluminum reinforcement inside top rail with picket stabilization beads facing picket holes.

NOTE: Cut rails on inside of marked lines for 1/8" aluminum bracket width.

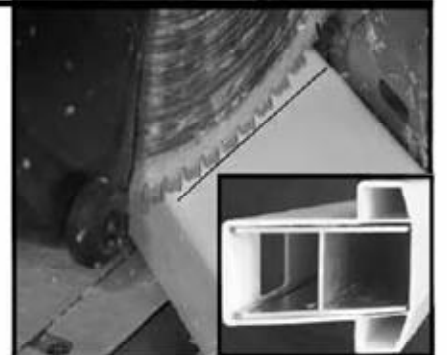

## Step 3: Bracket Placement & Rail Installation

(3a) Mark post for position of bottom rail. Install aluminum bracket 3/4" above bottom of rail using 3- # 12 x 1" screws provided.

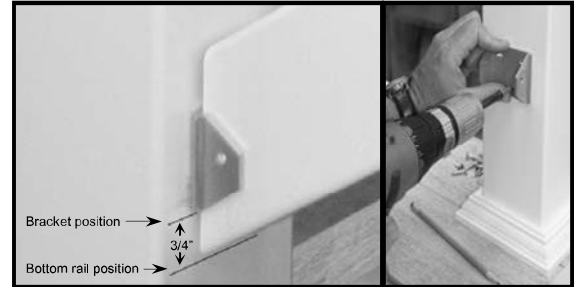

(3b) Place bracket covers on bottom rail.  
(Bracket covers may require additional modifications i.e. extending cutouts for pickets, and/or splitting covers along the score line.)



*(Tin snips, razor knife, pliers may be helpful.)*

Attach bottom rail to brackets using 2 - #8 screws provided.

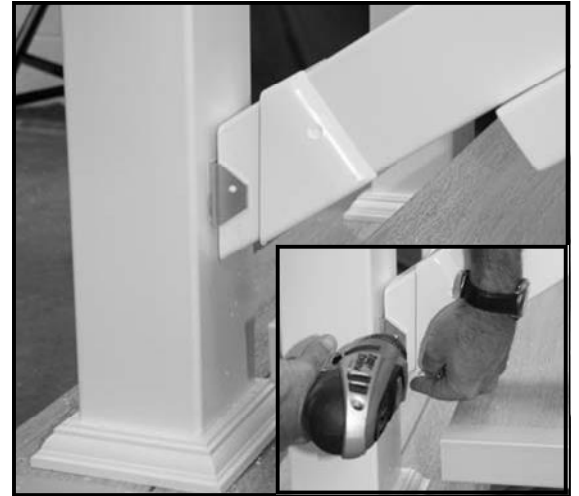

(3c) Insert one picket at each end of bottom rail. Slide aluminum brackets on ends of top rail. Place top rail and aluminum reinforcement on pickets. Mark desired position of aluminum bracket on posts. Remove top rail and screw aluminum bracket to post at marked position using 3- #12 screws provided.

*(Additional modifications may be required. – as shown in (3b) above.)*

Insert all pickets in bottom rail. Work top rail and aluminum reinforcement down into brackets and over pickets. Secure top rail to brackets using 2- #8 screws provided.

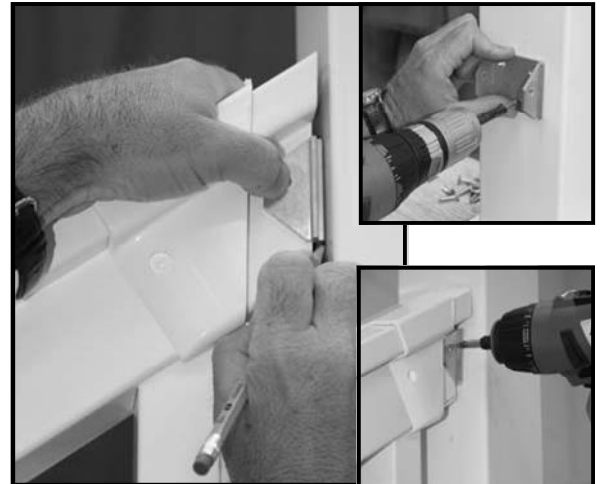

## Step 4: Install Bracket Covers

Push bracket covers towards mounting surface. Drive (2) #6 screws provided at an angle towards mounting surface and install.

Push or tap screw covers into position, (tab and groove, assure proper alignment.)

**Enjoy!!!**

